



HOME-ESS-HV-2.7K

Quick Installation Guide

Version 04



Android APP



iOS APP



1. Installation Precautions

Flow chart of installation steps:

Please follow the equipment installation steps process to ensure the equipment can be successfully installed.

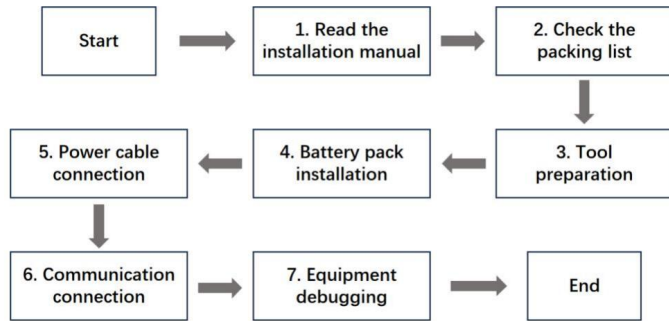

Schematic diagram of battery interface:

The definition of each interface must be clear during the installation process, otherwise the wrong connection will lead to installation failure or even damage to the equipment.

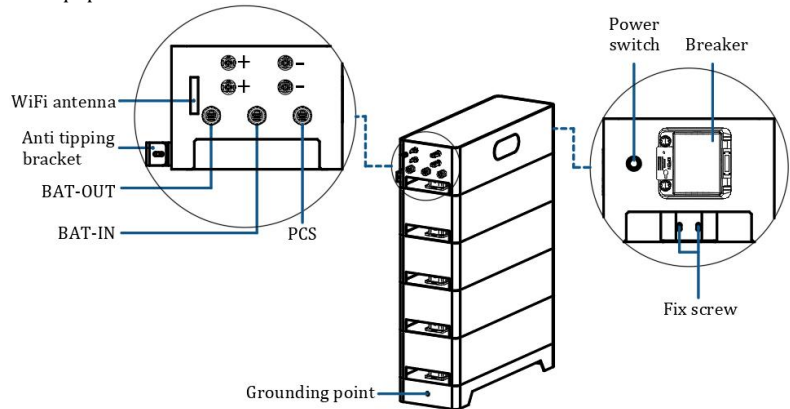

Please ensure that the installer meets the following requirements:

This system should only be installed by personnel with training and adequate knowledge of electrical power systems.

Please ensure that the installation location meets the following conditions:

- The installation and use environment need to comply with local laws and regulations and relevant international national and regional standards for lithium battery products.
- Install in a dry, well-ventilated environment and secure the equipment on a sturdy, level support surface.
- Avoid water accumulation in the installation location, and keep away from water sources such as faucets, sewer pipes, sprinklers, etc. to avoid water infiltration.
- The environment around the installation location is clean, and there is no infrared radiation, heat source, conductive dust, organic solvents and corrosive gases, etc.
- When the equipment is running, the temperature of the under-frame and heat sink will be relatively high, please do not install it in a place where it is easy to touch.
- When the equipment is running, do not block the ventilation openings or cooling system to prevent high temperature fires.
- Please choose a sheltered installation site, or build an awning to avoid direct sunlight or rain.

2. Check the packing list

Please refer to the packing items shown below, please check the packing list carefully, if any items are missing, please contact your dealer directly.

Battery energy Distribution Unit:

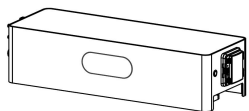

Battery energy Distribution Unit
(BDU)

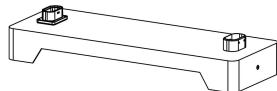

Installation base



Anti tipping bracket 1(shorter)*3



Anti tipping bracket 2(longer)*3



CAN communication line/1200mm



Power cable 1 Black/1200mm



Power cable 2 Red/1200mm



Expansion bolt *9



Hexagonal Screw M4x10*18/OT6-4



Quick Installation Guide



L-shaped hexagonal tool * 1

Battery module:



Battery module



Hexagonal Screw M4x10*2

3.Tool preparation

Step 1 : Protective equipment products must be worn and maintained during the installation process.



Safety gloves



Safety goggles



Safety shoes

Step 2 : Installation Tools: tools needed in the process of installing equipment, more effective to improve installation efficiency.



Phillips screw driver

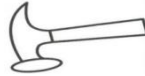

Hammer



Level



Ruler



Electric screwdriver



Marker pen

4.Battery pack installation

Attention should be paid to the following items before installation:

- Power cable specification: The matching power cable is 6AWG, and the max current is 60A. Please do not work under the condition of exceeding this current.
- Mounting space: Make sure that the battery system has enough space to install, make sure the ground is strong enough to bear the weight of the battery system.

The battery is in danger of falling, so the anti-tipping bracket must be firmly installed on the wall, and the battery and anti-tipping bracket must be reliably fixed (the battery and anti-tipping bracket should be locked with screws).

- Wiring: Make sure the power cable and ground wire are reasonable. Not easy to short-circuit, water and corrosion.

Floor installation:

Number of modules(N)	Number of brackets	Distance of each bracket 2 from the floor	Note
$3 \leq N \leq 6$	2 sets	$262\text{mm}/(100+162*N)\text{mm}$	N = the number of modules in a battery system
$6 < N \leq 8$	3 sets	$262\text{mm}/748\text{mm}/(100+162*N)\text{mm}$	
$8 < N \leq 10$	3 sets	$262\text{mm}/910\text{mm}/(100+162*N)\text{mm}$	
$10 < N \leq 12$	3 sets	$262\text{mm}/1072\text{mm}/(100+162*N)\text{mm}$	

Step 1: Locate drill holes in the wall

Locating drill holes in the wall using a bracket 2(longer) as a template with a level, position the holes on the wall, mark the positions of the 3 holes, and then drill 10mm holes to ensure that the depth of the holes exceeds 50mm. The positions of the two (or three) brackets 2 are shown in the table.

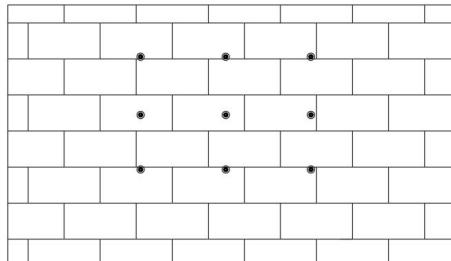
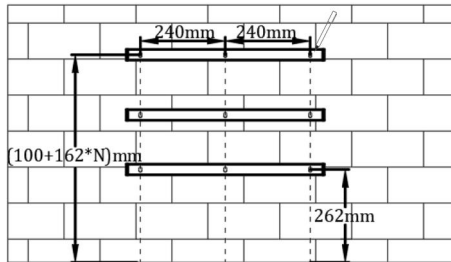

Step 2: Fix the anti tipping bracket 2

Fit the expansion tubes into the holes, pull them tight, and then use the expansion screws (packaged with expansion tube for use) to install and secure the wall mount bracket to the wall.

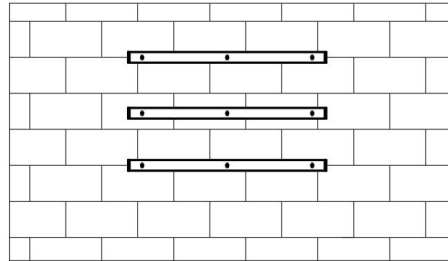
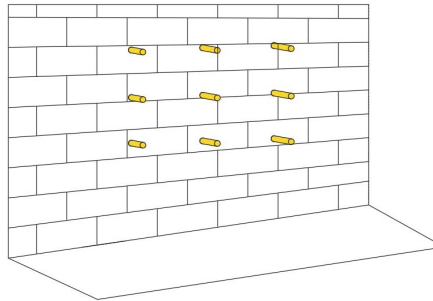

Step 3: Place the base

Place the base along the wall and the base distance from the wall is 26-34mm. The center hole of the bracket 2 is aligned with the center of the base. The locking hole of the base is placed on the right.

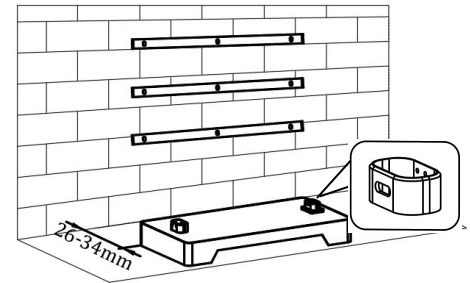
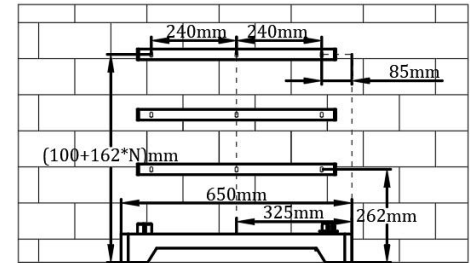

Step 4: Install the bracket 1

There are threaded holes on the back of the BDU and modules. Using the M4x10 screws to install the anti tipping bracket 1 (shorter) to it. Pay attention to the direction of bracket mounting.

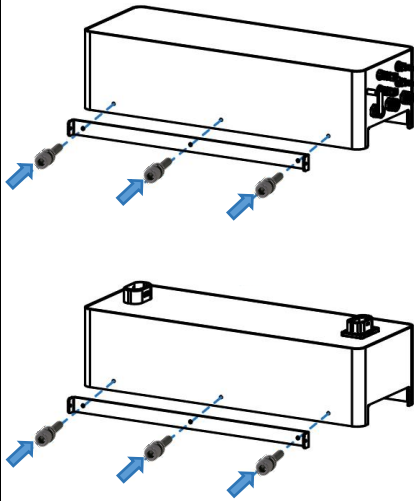

Step 5: Install the battery

Install the module and BDU in order from bottom to top. Observed from the both sides of the battery system, make sure that the locking holes on both sides of the anti tipping bracket and the locking holes on the side of the battery system overlap, if not, you need to re-adjust the position of the battery to make it overlap.

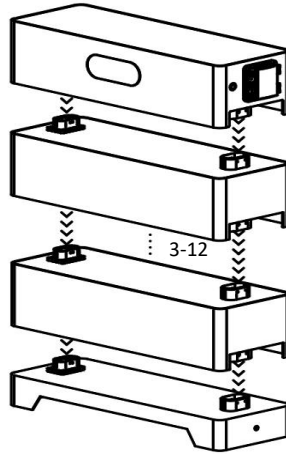

Step 6: Fix the battery module

Using the M4x10 screws to lock the bracket from both side of the BDU and modules, and all the connectors on the right side between the BDU, module and base. The distance between the battery and the inverter should be about 400mm.

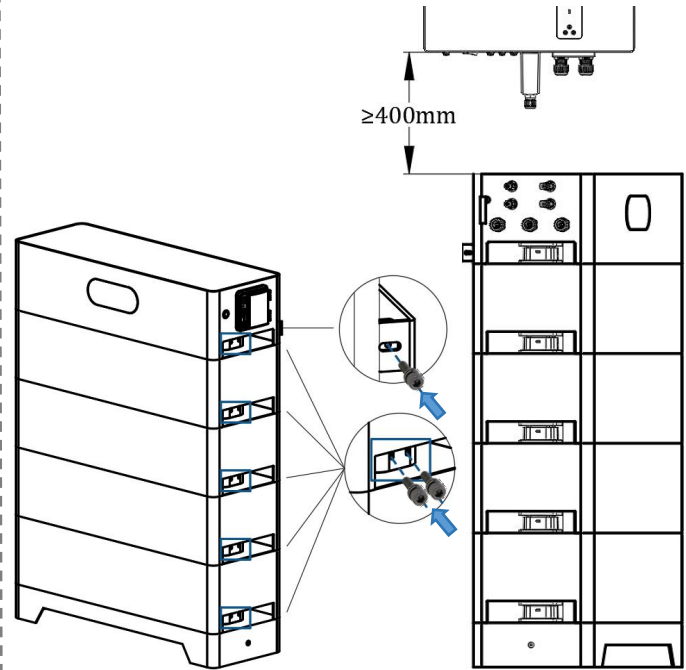

5. Power cable connection and communication connection

Installation Preparation:

Before connecting cables, make sure the battery and inverter are entirely switched off. Make sure all breaker switches are fully switched off.

Before connecting the power cables, using multi meter to measure cable continuity, short circuit, confirm positive and negative.

Step 1 :Connect the battery ground cable :

Customer needs to prepare the area of the grounding cable shall be at least 6mm², use a ground screw and terminal to connect the ground cable, and ground the battery. The bolt locking torque is 6NM.

Step 2 :Connect the battery to the inverter power supply

Connect the negative pole (P- terminal) of the battery and the BAT - terminal of the inverter with the power cable 1; connect the positive pole (P+ terminal) of the battery and the BAT + terminal of the inverter with the power cable 2 .

NOTE :

When the inverter is electrically connected, the inverter and batteries need to be powered off. Hear a sound locking into place as the cable connects to the terminal.

It is forbidden to mix batteries of different brands, specifications and batches, otherwise it will cause system failure.

Step 3: Connect the CAN communication line

Use the CAN communication cable to connect the inverter to the battery's PCS port.

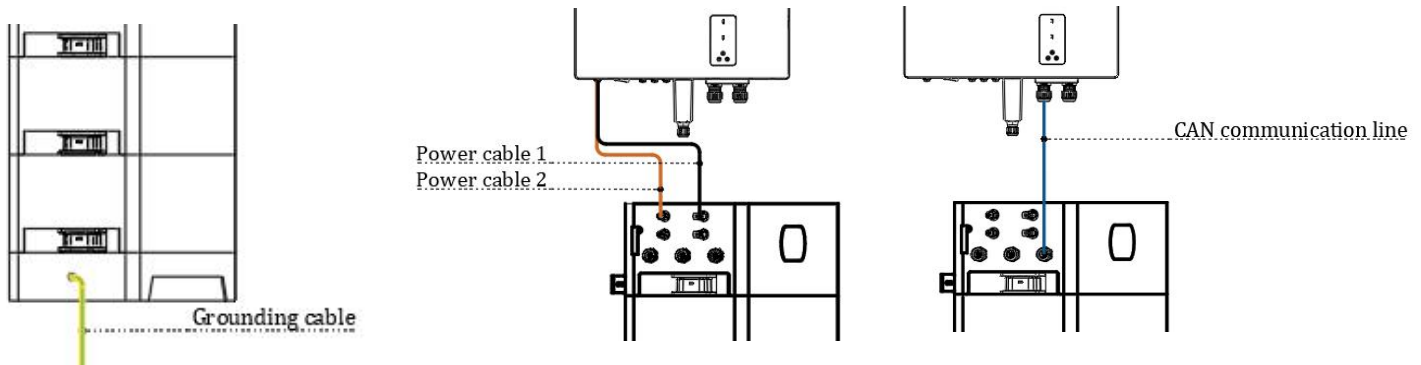

6. Equipment debugging

Step 1 : Equipment power on

Confirm again that the cables are connected in the correct order and the connection is firm before starting the test.

- 1) First turn on the inverter.
- 2) Then turn on the circuit breaker switch on the battery.
- 3) Next, .press the power switch power on the battery pack.
- 4) Observe the status on the battery panel to ensure it is normal.

NOTE :

The shut down procedure is opposite to the startup process, first shut down the power switch power on the battery; Then shut down the battery circuit breaker. Final turn off the inverter. When the system starts, ensure the boot sequence of each equipment, otherwise it may cause pre-charging and trigger the circuit breaker protection fault.

Step 2 : Inverter Protocol Selection:

The battery default factory CAN communication is Hanchu ESS protocol.

Protocol selection:

- 1) Check which protocols are supported by the inverter.
- 2) If the inverter supports the battery factory default protocol, select the corresponding protocol on the inverter directly.
- 3) If the inverter supports protocols other than the battery factory default protocol, select the same protocol on the battery and the inverter.

Battery protocol selection: select the interface and communication protocol matching with the inverter on the battery APP(Protocol options include HANCHU、PYLON、LUXPOWER、SOFARSOLAR), and the APP selection method is described in Monitor Usage Guide.

- 4) After setting, you can see the normal status information of the battery pack, such as voltage, SOC, etc. from the inverter.

Contact

Hotline:+86-51088876668/+86-51088865288

Service Email: service@hanchuess.com

Web: www.hanchuess.com